

# **A50/A51/A60**

---

**Feb. 1997 ( 1st Edition )**

**All Rights Reserved**

---

**Part I - A50/A51 RS-232 to RS-422/RS-485 Converter**

---

**A50/A51**

---

RS-232 to RS-422/RS-485  
Bidirectional Converter

---

## **Part II - A60 RS-232 Surge Protection**

---

### **A60**

---

**RS-232 Surge Protection  
Converter**

# Copyright Notice

This documentation is copyrighted by Moxa Technologies Co., Ltd. All rights are reserved. Moxa Technologies reserves the right to make improvements to the products described in this manual at any time without notice.

Information provided in this manual is intended to be accurate and reliable. However, Moxa Technologies assumes no responsibility for its use, nor for any infringements of rights of the fourth party which may result from its use.

MOXA is a registered trademark of Moxa Technologies Co., Ltd. The other trademarks in this manual belong to their manufacturers individually.

Turn PC into Online-Access-Server.

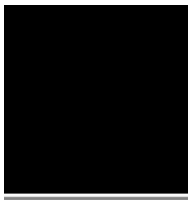

**Moxa Technologies Co., Ltd.**

Tel: +866-2-8665-6373

Fax: +886-2-8665-6372

**[www.moxa.com.tw](http://www.moxa.com.tw)**

**[support@moxa.com.tw](mailto:support@moxa.com.tw)**

# Moxa Inter



Customer's satisfaction is always our number one concern. To ensure customers get the full benefit of our services, Moxa Internet Services (MIS) have been built for technical support, product inquiry, new driver upgrade, etc.

The followings are the services we provide.

E-mail for technical support

*address* : support@moxa.com.tw

Ftp site for free driver upgrade

*address* : ftp.moxa.com or ftp.moxa.com.tw

*user ID* : ftp

*password* : your\_email\_address

World Wide Web (WWW) for product info.

*address* : www.moxa.com or www.moxa.com.tw

# Table of Contents

---

## Part I - A50/A51 RS-232 to RS-422/RS-485 Converter

---

<b>Chapter 1. Introduction .....</b>	<b>1</b>
1.1 Overview	1
1.2 Features and Specifications	2
1.3 Package Check List	5
<b>Chapter 2. Installation .....</b>	<b>7</b>
2.1 Installation Procedure	7
2.2 Switch Function Description	7
2.3 LED Indicators	8
2.4 RS-422/RS-485 Pinouts	9
<b>Chapter 3. Operation .....</b>	<b>11</b>
3.1 Point-to-point	12
3.2 Multidrop	14
3.3 Simplex/Transmit, Receive	17
3.4 Self Test	19
<b>Appendix A RS-232 Pinouts and Cable Wiring .....</b>	<b>21</b>
<b>Appendix B Impedance Matching and Termination Resistors.....</b>	<b>25</b>
<b>Appendix C Troubleshooting .....</b>	<b>27</b>

---

# Table of

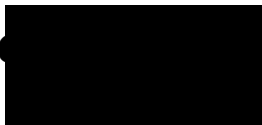

---

## Part II - A60 RS-232 Surge Protection

---

<b>Chapter 1. Introduction.....</b>	<b>29</b>
1.1 Overview	30
1.2 Features and Specifications	30
1.3 Package Check List	31
<b>Chapter 2. Installation.....</b>	<b>33</b>
2.1 Installation Procedure	33
2.2 LED Indicators	34
2.3 Self Test	36
<b>Appendix A RS-232 Pinouts and Cable Wiring.....</b>	<b>37</b>
<b>Appendix B Troubleshooting .....</b>	<b>41</b>

---



## 1.1 Overview

The MOXA RS-232 to RS-422/RS-485 bidirectional converters, A50 and A51, are designed to convert unbalanced (single-ended) RS-232 signals to balanced (differential) RS-422/RS-485 signals, and vice versa. They are the best choices for those who want to control devices at longer distance and/or to communicate with several devices via merely one link, particularly in the industry area. Point-to-point, multidrop and simplex operations are available for most users' needs.

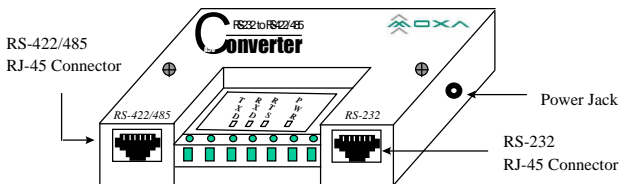

### Outlook of A50

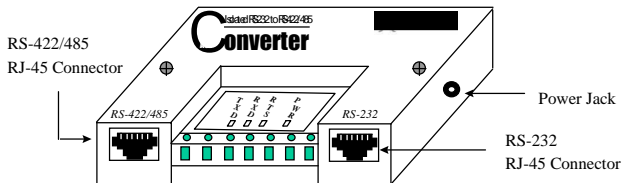

## Outlook of A51

### 1.2 Features and Specifications

#### *Features*

Both A50 and A51 are RS-232 to RS-422/RS-485 bidirectional converters except that A51 has one more feature: isolation protection, which provides high voltage protection up to 2000V.

All the switches, SW1 and SW2, of A50/A51 are designed to be inside of the converter to protect switch settings from unintended change and introducing communication error without any warning. Hence, it is necessary to take the two screws off and open the cover up if you need to change the operation mode via sliding the switches.

The A50/A51 must be powered either from a DC +9V to +30V,

150mA power adapter or the pin 6 and pin 7 of the Terminal Block.

LED indicators are provided to show the status of data transmitting/receiving, RTS signal and Power.

To avoid over-current from the remote ground to converter's ground, an protect resistor has been added inside the A50/A51.

### *Specifications*

- ✓ Power Supply - DC +9V to +30V, 150mA
- ✓ Data Rate - Up to 921600 bps under 500 ft (0.15 Km)
- ✓ Distance - Up to 4000 ft (1.2 Km) under 115200 bps
- ✓ RS-232 RJ-45 Connector -  
Supports TxD, RxD, DTR, DSR, RTS, CTS, DCD, GND
- ✓ RS-422/RS-485 RJ-45 Connector -  
Supports TxDA, TxDB, RxDA, RxDB, GND
- ✓ RS-422/RS-485 Terminal Block Connector -  
Supports TxDA, TxDB, RxDA, RxDB, GND, PWR, PWR  
GND
- ✓ Switch - SW1 : for full/half-duplex mode  
SW2 : for Tx (driver) and Rx (receiver) state

- ✓ Isolation Protection - for A51 only, up to 2000V.
- ✓ Terminal Resistor - RT1 space reserved for RS-422/RS-485 receiver signal.
- ✓ Mounting Kit - Plastic Plates and screws for mounting A50/A51 on the wall or any surface.

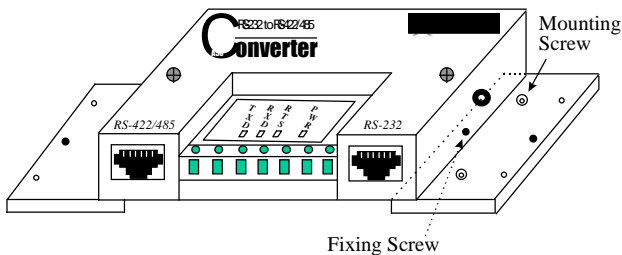

**A50/A51 with Mounting Kit**

### **1.3 Package Check List**

Upon unpacking your A50 or A51 package, you should find the following items:

- ✓ A50 (or A51) RS-232 to RS-422/RS-485 bidirectional converter (with isolation protection if A51)
- ✓ One power adapter
- ✓ Mounting Kit
- ✓ A50/A51/A60 User's Manual



## 2.1 Installation Procedure

As RS-232 or RS-422/RS-485 port are labeled clearly on the surface of the A50/A51 converter, please prepare the RS-232 cable (refer to Appendix A, RS-232 Cable Wiring) and decide the operation mode as well as 2/4-wire cable (refer to Chapter 3, Operation) in advance.

Take off the two screws on top of the converter and open the cover up if you need to change the operation mode via sliding the switches.

## 2.2 Switch Function Description

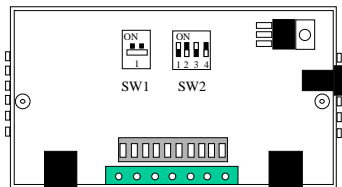

Inside look of A50/A51

Switch settings table of SW1 and SW2 is as follows:

SW1	
*Full-duplex mode	Off
Half-duplex mode	On

SW2	Pin1	Pin2	Pin3	Pin4
*TxD always enabled	On	Off	X	X
TxD always disabled	Off	Off	X	X
TxD enabled by RTS	Off	On	X	X
*RxD always enabled	X	X	On	Off
RxD enabled by /RTS	X	X	Off	On

Note: ‘ \* ‘ means default settings , ‘ X ‘ means don’t care

## 2.3 LED Indicators

There are LED indicators for TxD, RxD, RTS, and PWR on top of A50/A51. The indicator is not lighted on when not connected with signal or power. On the contrary, it will be lighted on and be in one of the red, green or orange colors.

TxD indicator stands for data transmitting from RS-232 to RS-422/RS-485. It shows green when connected and no data transmitting. It shows orange when connected and transmitting data.

RxD indicator stands for data transmitting from RS-422/RS-485 to RS-232. It shows red when connected and no data received. It shows orange when connected and receiving data (In half-duplex mode, it shows red when line is not connected due to the characteristics of ICs for RS-485).

RTS indicator is for RS-232 RTS signal. It shows red when connected and RTS signal turned on. It shows green when connected and RTS signal turned off.

PWR indicator is red when power is on and not lighted when power is off or not connected.

## 2.4 RS-422/RS-485 Pinouts

RS-422/RS-485 interface with RJ-45 Jack connector or Terminal Block Connector is depicted as follows.

**RJ-45 Connector**

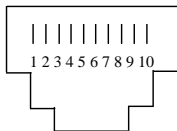

**Terminal Block Connector**

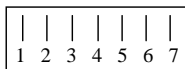

A50/A51 RJ-45 Jack		A50/A51 Terminal Block	
Connector Pinouts	Signals	Connector Pinouts	Signals
1	nc	1	TxD B
2	nc	2	TxD A
3	GND	3	RxD B
4	TxD B	4	RxD A
5	TxD A	5	GND
6	RxD A	6	Power GND
7	RxD B	7	Power Input
8	GND		
9	nc		
10	nc(not connected)		

**Note :** Pin 6 and Pin 7 of Terminal Block are for Power GND and Power Input, which is an alternate option for power adapter. Be careful that DO NOT confuse RS-422/RS-485 GND with Power GND.

**Note :** Under half-duplex mode (SW1 in ON mode), the couples of (TxD B, RxD B) and (TxD A, RxD A) are shorted inside the converter for convenience. Users can save the trouble with shorting the wires.

The A50 (or A51) supports 5 kinds of operations. They are:

- ✓ Point-to-point/4-wire Full Duplex
- ✓ Point-to-point/2-wire Half Duplex
- ✓ Multidrop/4-wire Full Duplex
- ✓ Multidrop/2-wire Half Duplex
- ✓ Simplex/Transmit, Receive Only

All the operations are to be described below. And TA, TB, RA and RB represent TxD A, TxD B, RxD A and RxD B signal lines of the RJ-45 RS-422/RS-485 connector or the Terminal Block, respectively.

**Note :** If possible, connect GND of both sides together to gain better signals. That is, you may need one more GND connection in addition to 4-wire or 2-wire connection.

**Note :** For A51, connecting GND at the Terminal Block to the earth ground to provide a ground path to prevent electric shock caused by lightning, no matter RJ-45 or Terminal Block RS-422/RS-485 is used.

### 3.1 Point-to-point

Point-to-point configuration means two devices which locate at two different places can be linked together to communicate through a couple of A50 (or A51) converters.

#### *4-wire Full Duplex*

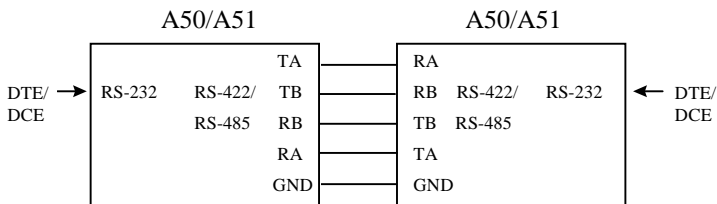

In the graph, TA, TB, RA and RB could be either from RJ-45 or Terminal Block. The settings of the switches for each A50 (or A51) are as follows:

SW1	
Full-duplex mode	Off

SW2	Pin1	Pin2	Pin3	Pin4
TxD always enabled	On	Off	X	X
RxD always enabled	X	X	On	Off

### 2-wire Half Duplex

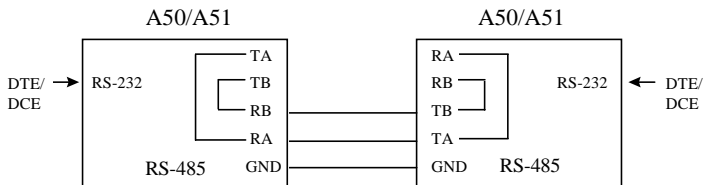

In the graph, TA, TB, RA and RB could be either from RJ-45 or Terminal Block. The settings of the switches for each A50 (or A51) are as follows:

SW1		SW2		Pin1	Pin2	Pin3	Pin4
Half-duplex mode	On	TxD enabled by RTS	Off	On	X	X	
		RxD enabled by / RTS	X	X	Off	On	

## 3.2 Multidrop

Multidrop configuration means that more than two devices (Max. 10 for RS-422; Max. 32 for RS-485) can be linked all together to communicate one another through many A50 (or A51) devices. In this configuration, one of the A50 (or A51) will be connected to a master device and the rest of A50 (or A51) devices will be connected to any other slave devices.

### *4-wire Full Duplex*

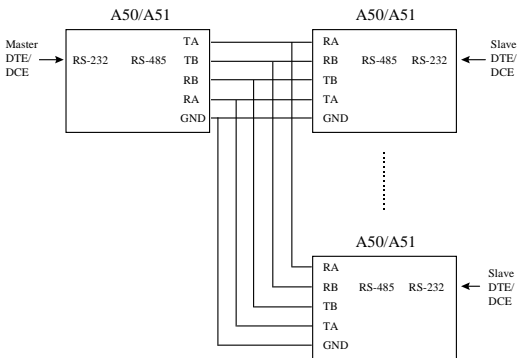

In the graph, TA, TB, RA and RB could be either from RJ-45 or Terminal Blocks. The settings of the switches for each A50 (or A51) are as follows:

SW1	
Full-duplex mode	Off

SW2 for Master	Pin1	Pin2	Pin3	Pin4
TxD always enabled	On	Off	X	X
RxD always enabled	X	X	On	Off

SW2 for Slaves	Pin1	Pin2	Pin3	Pin4
TxD enabled by RTS	Off	On	X	X
RxD always enabled	X	X	On	Off

## *2-wire Half Duplex*

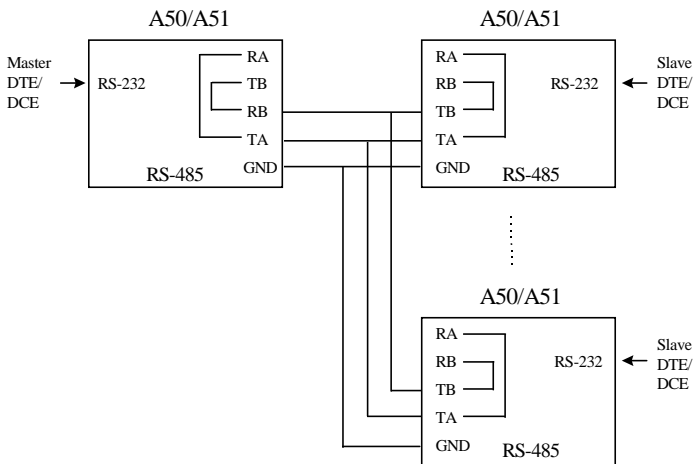

In the graph, TA, TB, RA and RB could be either from RJ-45 or Terminal Block. The settings of the switches for each A50 (or A51) are as follows:

SW1		SW2	Pin1	Pin2	Pin3	Pin4
Half-duplex mode	On	TxD enabled by RTS	Off	On	X	X
		RxD enabled by / RTS	X	X	Off	On

### **3.3 Simplex/Transmit, Receive**

Simplex configuration means that more than two devices (Max. 10 for RS-422; Max. 32 for RS-485) can be linked all together to communicate through many A50/A51 devices. Its configuration is like the Multidrop's, but the master device can talk only and the slave devices can listen only.

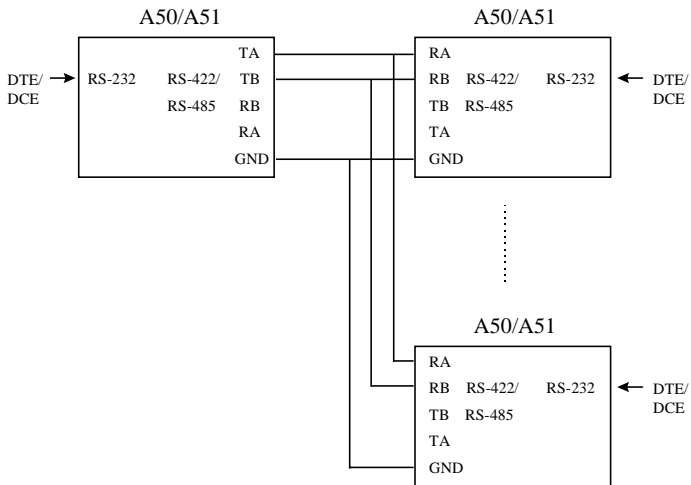

In the graph, TA, TB, RA and RB could be either from RJ-45 or Terminal Block. The settings of the switches for each A50 (or A51) are as follows:

SW1	
Full-duplex mode	Off

SW2	Pin1	Pin2	Pin3	Pin4
TxD always enabled	On	Off	X	X
RxD always enabled	X	X	On	Off

### 3.4 Self Test

This configuration is for A50/A51 self test. Run terminal emulation program to see if what you received is what you typed.

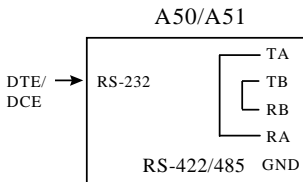

In the graph, TA, TB, RA and RB could be either from RJ-45 or Terminal Block. The settings of the switches for each A50 (or A51) are as follows:

SW1	
Half-duplex mode	On

SW2	Pin1	Pin2	Pin3	Pin4
TxD always enabled	On	Off	X	X
RxD always enabled	X	X	On	Off



# Appendix A RS-232 Pinouts & Cable Wiring

RS-232 interface with RJ-45 connector is depicted as follows.

## RJ-45 Connector

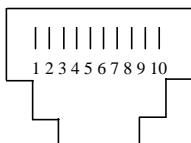

### A50/A51 RJ-45 Connector Pinouts

### RS-232 Signals

1	DCD	Always On
2	DSR	┌──────────┐ └──────────┘
3	RTS	
4	GND	┌──────────┐ └──────────┘
5	TxD	
6	RxD	┌──────────┐ └──────────┘
7	GND	
8	CTS	┌──────────┐ └──────────┘
9	DTR	
10	-	

**Note :** Each group of (RTS, CTS) and (DTR, DSR) pins have been shorted on A50/A51, which release the users from the hardware flow control cable wiring problem. Thus, there are two types of RS-232 cable wiring which are listed below.

**Type I:** To connect RS-232 side of A50/A51 to a DTE (e.g. PC COM1/2) or DCE . (Please check the precise DTE/DCE pinouts, the following DTE/DCE pinouts is just an example)

<b>A50/A51 RJ-45 Connector</b>	<b>DTE DB-25 Male</b>	<b>A50/A51 RJ-45 Connector</b>	<b>DTE DB-9 Male</b>
1 DCD	8 DCD	1 DCD	1 DCD
2 DSR	20 DTR	2 DSR	4 DTR
3 RTS	5 CTS	3 RTS	8 CTS
5 TxD	3 RxD	5 TxD	2 RxD
6 RxD	2 TxD	6 RxD	3 TxD
7 GND	7 GND	7 GND	5 GND
8 CTS	4 RTS	8 CTS	7 RTS
9 DTR	6 DSR	9 DTR	6 DSR

A50/A51 RJ-45 Connector		DCE DB-25 Female	
1	DCD	8	DCD
2	DSR	6	DTR
3	RTS	4	CTS
5	TxD	2	RxD
6	RxD	3	TxD
7	GND	7	GND
8	CTS	5	RTS
9	DTR	20	DSR

**Type 2:** To connect RS-232 side of A50/A51 to a DTE, e.g. terminal or PC COM1/2, with 3-pin wiring if don't care Hardware flow control.

A50/A51 RJ-45 Connector		DTE DB-25 Male		A50/A51 RJ-45 Connector		DTE DB-9 Male	
5	TxD	3	RxD	5	TxD	2	RxD
6	RxD	2	TxD	6	RxD	3	TxD
7	GND	7	GND	7	GND	5	GND
3	RTS	5	CTS	3	RTS	8	CTS
8	CTS	4	RTS	8	CTS	7	RTS
2	DSR	20	DTR	2	DSR	4	DTR
9	DTR	6	DSR	9	DTR	6	DSR
1	DCD	8	DCD	1	DCD	1	DCD

<b>A50/A51 RJ-45 Connector</b>		<b>DCE DB-25 Female</b>	
5	TxD	2	RxD
6	RxD	3	TxD
7	GND	7	GND
3	RTS	4	CTS
8	CTS	5	RTS
2	DSR	6	DTR
9	DTR	20	DSR
1	DCD	8	DCD

## Appendix B Impedance Matching and Termination Resistors

---

When an electrical signal travels through two different resistance junctions in a transmission line, the mismatch will sometimes cause signal reflection. Signal reflection causes signal distortion, which in turn will contribute communication errors. The solution to this problem is to establish the same impedance at the line ends as in the line itself by terminating them with resistors.

It is normally sufficient when the value of the termination resistor equals the characteristic impedance of the transmission line. The resistors should be added near the receiving side. For example,

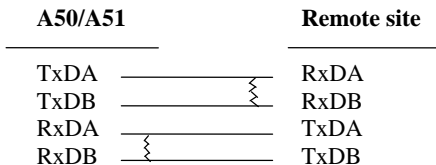

**Note:**

1.  $\zeta$  stands for termination resistor near the receiving side. RT1 is the space reserved inside A50/A51 for this purpose.
2. The suggested termination resistor for AWG #26 cable is 100 ohm.
3. The suggested termination resistor for phone cable is 600 ohm.

## Q1. Failure of data transmission.

### *Solutions:*

1. Check that the right power adapter is applied.
2. Check that the RS-232 link is proper.
3. Check that the RS-422/RS-485 link is proper.
4. Check that the SW1 and SW2 are set properly.

## Q2. Data loss or error.

### *Solution:*

Check that the data rate, data format are the same for both devices.

## Q3. How do I do self-test on A50/A51?

### *Solution:*

Refer to Chapter **3.4 Self Test** .



## 1.1 Overview

The MOXA RS-232 Surge Protection converter, A60, is designed to protect the RS-232 communication line from TOV (Transient Over Voltages) which comes from lightning, electrostatic discharge and other forms. TOV is always the major factor which damages components and makes ports unreliable. To improve this problem, we add Transient Voltage Suppressor to our I/O ports to clamp surge voltage to protect ports from TOV.

Due to the impulse signal generated by inductive devices in factory, the surge protection is best suited for the factory automation applications.

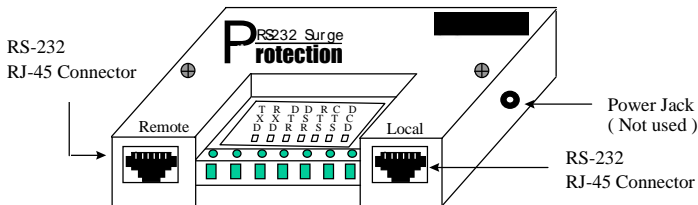

**Outlook of A60**

## **1.2 Features and Specifications**

### *Features*

A60's main feature is surge protection up to 2000V. No switch is needed. No power is needed. LED indicators are provided to show the status of data transmitting/receiving, modem control signals and DCD.

### *Specifications*

- ✓ RS-232 RJ-45 Connectors : supports TxD, RxD, DTR, DSR, RTS, CTS, GND, DCD
- ✓ RS-232 Terminal Block : supports TxD, RxD, DTR, DSR, RTS, CTS, GND
- ✓ LED Indicators : for TxD, RxD, DTR, DSR, RTS, CTS, DCD
- ✓ Surge Protection : up to 2000V, preventing surge from remote site.
- ✓ Mounting Kit : plastic plates and screws for mounting A60 on the wall or any surface.

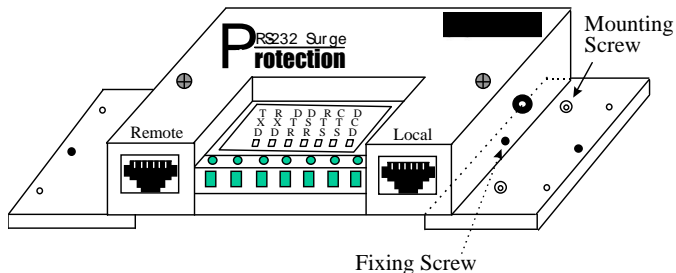

**A60 with Mounting Kit**

## 1.3 Package Check List

Upon unpacking your A60 package, you should find the following items:

- ✓ A60 RS-232 surge protection converter
- ✓ Mounting Kit
- ✓ A50/A51/A60 User's Manual



## **2.1 Installation Procedure**

Even though the local and remote ports of A60's are labeled on the surface of the A60 converter, please take care when connecting the cables to the A60 and the hosts. Note that the surge from both the local and the remote site is blocked by the A60. However, the LED indicators and the local host are under surge protection if and only if the surge comes in from the remote port of A60. Hence, it is recommended to keep A60 as close as possible to the local host. Otherwise, you may risk damaging the A60 itself as well as the local host if surge occurs between the A60's local port and the host.

In addition, you may need a couple of A60s, if both local and remote hosts are to be protected from surge.

Note that remote port and Terminal Block are actually the same except that DCD signal is not available in Terminal Block.

It is recommended to connect GND at the Terminal Block to the earth ground to provide a ground path to prevent electric shock caused by lightning, no matter RJ-45 or Terminal Block is used.

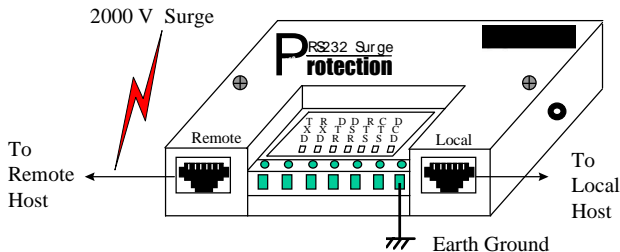

Please prepare the RS-232 cables, referring to Appendix A, RS-232 Cable Wiring.

## 2.2 LED Indicators

There are LED indicators for TxD, RxD, DTR, DSR, RTS, CTS, and DCD on top of A60. The indicators are not lighted on when not connected with signals. On the contrary, they will be lighted on and be one of the red, green or orange colors.

### TxD indicator (signal from local port)

Green : when connected correctly and no data transmitting.

Orange : when transmitting data from local to remote site.

**RxD indicator (signal from remote port )**

Green : when connected correctly and no data receiving.

Orange : when receiving data from remote to local site.

**DTR/RTS indicators (signal from local port)**

Red : when connected and DTR (or RTS) signal turned on.

Green : when connected and DTR (or RTS) signal turned off.

**DSR/CTS/DCD indicators (signal from remote port)**

Red : when connected and DSR (or CTS/DCD) signal turned on

Green : when connected and DSR (or CTS/DCD) signal turned off.

## 2.3 Self Test

This configuration is for A60 self-test. Run terminal emulation program to see if what you received is what you typed.

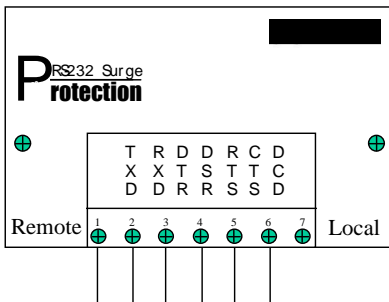

In the above graph, all the signal lines could be either from remote site RJ-45 or Terminal Block and shorted as shown.

# A

## ppendix A

### RS-232 Pinouts and Cable Wiring

---

Below is RS-232 pinouts for RJ-45 connector or Terminal Block.

**RJ-45 Connector**

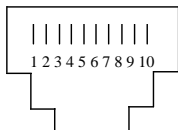

**Terminal Block Connector**

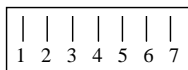

**A60 RJ-45**

**Connector Pinouts**

**Signals**

---

1	DCD
2	DSR
3	RTS
4	GND
5	TxD
6	RxD
7	GND
8	CTS
9	DTR
10	-

**A60 Terminal Block**

**Connector Pinouts**

**Signals**

---

1	TxD
2	RxD
3	DTR
4	DSR
5	RTS
6	CTS
7	GND

There are two types of RS-232 cable wiring which are listed below.

- Note:**
1. Terminal Block supports no DCD signal.
  2. DTE: Data Terminal Equipment like terminal or PC COM1/2; DCE: Data Communication Equipment like modem. Please check the precise DTE/DCE pinouts, the following DTE/DCE pinouts is just an example.

**Type 1:** To connect RS-232 local/remote port of A60 to a DTE or DCE.

A60	DTE DB-25 Male	A60	DTE DB-9 Male
DCD —————	8 DCD	DCD —————	1 DCD
DSR —————	20 DTR	DSR —————	4 DTR
RTS —————	5 CTS	RTS —————	8 CTS
TxD —————	3 RxD	TxD —————	2 RxD
RxD —————	2 TxD	RxD —————	3 TxD
GND —————	7 GND	GND —————	5 GND
CTS —————	4 RTS	CTS —————	7 RTS
DTR —————	6 DSR	DTR —————	6 DSR

<b>A60</b>	<b>DCE DB-25 Female</b>	
DCD —————	8	DCD
DSR —————	6	DTR
RTS —————	4	CTS
TxD —————	2	RxD
RxD —————	3	TxD
GND —————	7	GND
CTS —————	5	RTS
DTR —————	20	DSR

**Type 2:** To connect RS-232 local/remote port of A60 to a DTE with 3-pin wiring if don't care hardware flow control.

<b>A60</b>	<b>DTE DB-25 Male</b>	
TxD —————	3	RxD
RxD —————	2	TxD
GND —————	7	GND
RTS	5	CTS
CTS	4	RTS
DSR	20	DTR
DTR	6	DSR
DCD	8	DCD

<b>A60</b>	<b>DTE DB-9 Male</b>	
TxD —————	2	RxD
RxD —————	3	TxD
GND —————	5	GND
RTS	8	CTS
CTS	7	RTS
DSR	4	DTR
DTR	6	DSR
DCD	1	DCD

<b>A60</b>		<b>DCE</b>	<b>DB-25 Female</b>
TxD	————	2	RxD
RxD	————	3	TxD
GND	————	7	GND
RTS		4	CTS
CTS		5	RTS
DSR		6	DTR
DTR		20	DSR
DCD		8	DCD



**Q1. Failure of data transmission.**

*Solutions:*

Check that the RS-232 link is proper.

**Q2. Data loss or error.**

*Solution:*

1. Check that the data rate, data format are the same for both devices.
2. Surge occurs during the data transferring. Error detection and recovery should be taken in applications.

**Q3. How do I do self-test on A50?**

*Solution:*

Refer to Chapter 2.3, **Self Test**.